



CONTINENTAL DIAMOND TOOL
CORPORATION

DIAMOND DRESSERS



We're setting the new standard.

SINGLE POINT DIAMOND DRESSERS

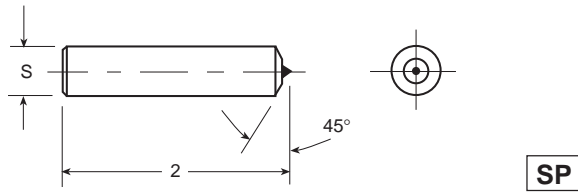

SP

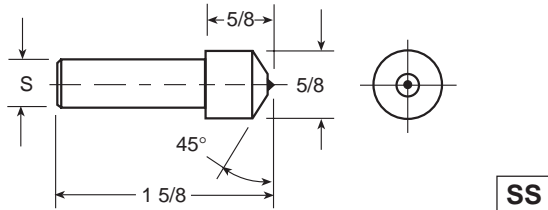

SS

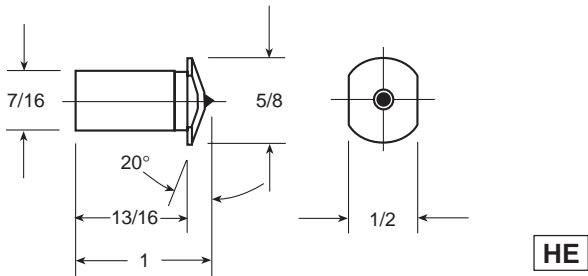

HE

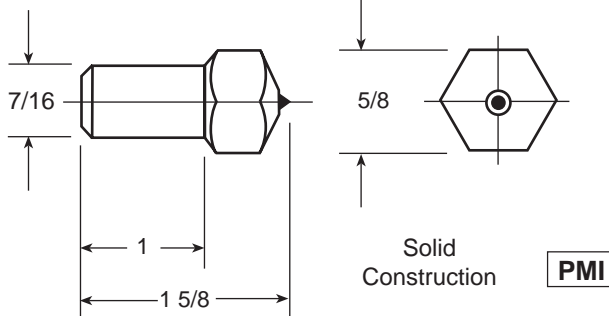

PMI

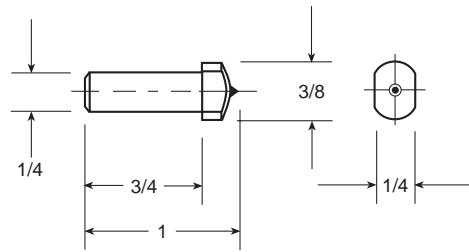

BR

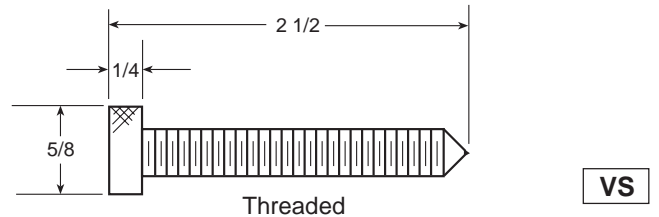

VS

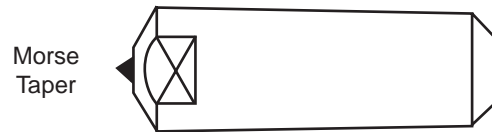

MT

HOW TO ORDER

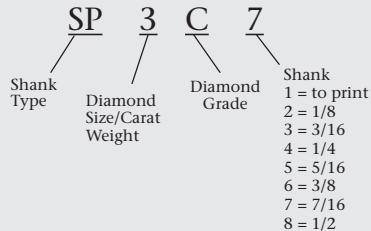

Dia.	Weight
1	= .20 ct
2	= .25
3	= .33
4	= .50
5	= .75
6	= 1.00
7	= 1.25
8	= 1.50
9	= 1.75
10	= 2.00

TWIST-A-DRESSERS

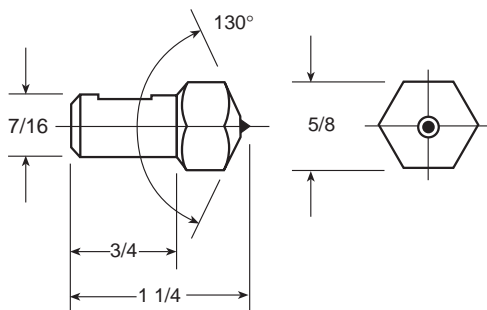

Hex head will index independent of shank. This enables diamond to be rotated without loosening the tool from the machine. This encourages the operator to index the diamond, thereby increasing diamond life and reducing down time.

HOW TO ORDER

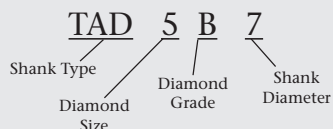

THREE LAYER CLUSTERS

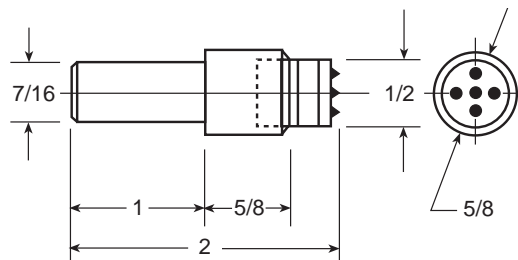

3 Layered cluster tool having 5 stones per layer.

Many stones do the work rather than a large, more costly single point stone. Diamond wears away until entire tool is consumed for maximum economy and efficiency.

Tool #	Caret Weight
CL23L	2.00
CL33L	3.00
CL43L	4.00
CL53L	5.00

MULTI-SET CLUSTERS

Tool #	Number of Diamonds	Carat Weight
SF31-7	3	1.0
SF32-7	3	2.0
SF33-7	3	3.0
SF34-7	3	4.0
CL5LD7	5	1.0
CL5SD7	5	1.25
CL5HD7	5	1.75
CL7LD7	7	1.25
CL7SD7	7	1.75
CL7HD7	7	2.25
CL9SD7	9	3.0
CL9HD7	9	5.0

RESETS

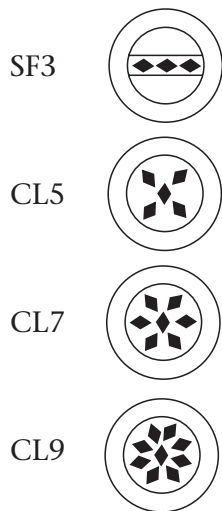
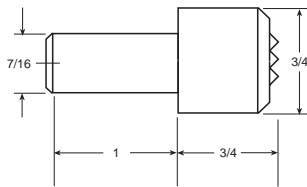

HOW TO ORDER

CL5SD 7
 Tool # Shank Size
 6 = 3/8
 7 = 7/16
 8 = 1/2

BLADE TYPE DRESSERS

- Diamonds are hand set with a specific diamond pattern to provide consistency throughout tool life for uniform wheel conditioning
- Precision dressing
- Dressing difficult profiles and straight applications
- Long life
- No resetting

CS SERIES

TOOL #	DIAMOND WIDTH	SECTION DEPTH	SIZE THICKNESS
CSA .030	20mm	15mm	.030
CSA .036			.036
CSA .043			.043
CSA .055			.055
CSB .030	10mm	15mm	.030
CSB .036			.036
CSB .043			.043
CSB .055			.055
CSC .036	15mm	10mm	.036
CSC .043			.043
CSC .055			.055
CSD .030	10mm	10mm	.030
CSD .036			.036
CSD .043			.043
CSD .055			.055
CFA .030	20 mm	15mm	.030
CFA .036			.036
CFA .043			.043
CFA .055			.055
CFB .030	10mm	15mm	.030
CFB .036			.036
CFB .043			.043
CFB .055			.055
CFC .036	15mm	10mm	.036
CFC .043			.043
CFC .055			.055
CFD .030	10mm	10mm	.030
CFD .036			.036
CFD .043			.043
CFD .055			.055

SHANKS FOR BLADE TYPE TOOLS

TOOL #	Shank Size
BTH .375	3/8 Shank
BTH .437	7/16 Shank
BTH .0 MT	#0 Morse Taper
BTH 1 MT	#1 Morse Taper

BLADE TYPE DRESSERS ON SHANKS

Fabricated as one unit

	Diamond Width	Diamond Length	Size Thickness
CT-A .030 ___ - ___	20mm	15mm	.030
CT-A .036 ___ - ___			.036
CT-A .043 ___ - ___			.043
CT-A .055 ___ - ___			.055
CT-B .030 ___ - ___	10mm	15mm	.030
CT-B .036 ___ - ___			.036
CT-B .043 ___ - ___			.043
CT-B .055 ___ - ___			.055
CT-C .036 ___ - ___	15mm	10mm	.036
CT-C .043 ___ - ___			.043
CT-C .055 ___ - ___			.055
CT-D .030 ___ - ___	10mm	10mm	.030
CT-D .036 ___ - ___			.036
CT-D .043 ___ - ___			.043
CT-D .055 ___ - ___			.055

1. Always apply full flood coolant directly on diamond before making any contact with the grinding wheel.
2. Mount the blade parallel with the direction of the wheel's rotation and perpendicular to the wheel's radius at point of contact.
3. Mount with minimum overhang from the dresser post.
4. For contour dressing, mount so that the aligned diamond surface (L or R) is the leading edge of the feed direction.
5. Inclination of up to 30 degrees is allowable for contour dressing.
6. Ideal dressing depth: .0005 - .001.
7. Initial feed rate: 24 IPM

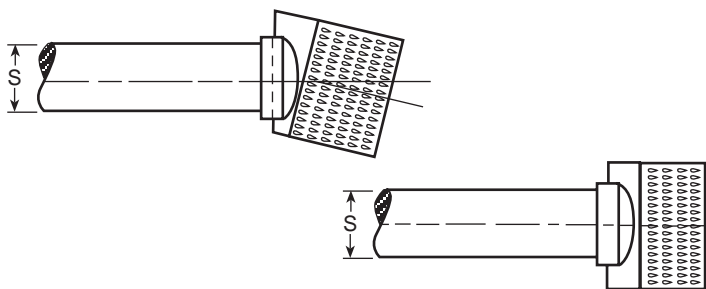

HOW TO ORDER

CT **B** - **.043** - **15** **7**
 Tool Type Diamond Section Size Diamond Thickness Blade Offset 00 = Zero 10 = 10 Degrees 15 = 15 Degrees Shank 6 = 3/8" 7 = 7/16" 8 = 1/2" OMT = #0 Morse Taper 1 MT = #1 Morse Taper

DONUT CLUSTERS

DCM-87

Donut Cluster Diamond Dresser in which natural diamonds are set in a circular crown at 15° angle. As soon as the diamonds on the indexed position are completely used up, the tool can be rotated for new points.

APPLICATIONS:

- All types of larger wheels where fine truing is considered important.
- Specially recommended for cylindrical grinders.

ADVANTAGES:

- The diamonds can be completely used up and resetting is redundant.
- Since two or more diamonds come in contact with the wheel the work load on the diamonds is divided and the diamonds last longer.
- A larger area of the wheel is dressed more efficiently in a relatively shorter time than a single point.
- As several points are in use simultaneously the feed may be safely increased.
- Finer finish is obtained on the wheel due to the crystal shape of the diamonds employed.
- Can be used for side dressing.

DONUT CLUSTERS

TOOL #DCM 87

Large Wheel

49 hand-set diamonds for long life, better truing. Approximately 3 carats.

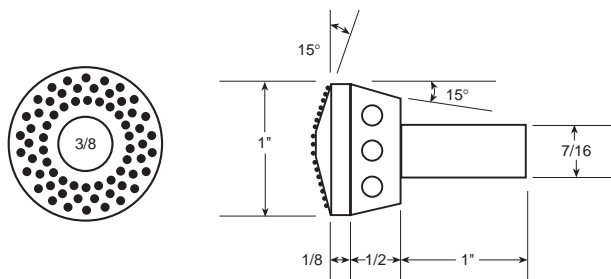

GRIT DRESSER TOOLS

CDT Grit Dressers are tools having uniform diamond distributed in a tough matrix for long life and dependability. These ready to use tools have new diamond points exposed and are ready to yield a rapid, required finish. Additionally, wheel truing and dressing is accomplished with maximum efficiency for more pieces per dress. Grit dressers are the most economical way to dress grinding wheels.

Grit Dresser application suggestions:

- Because of the large diamond section, dressing can be accomplished quickly.
- Normal tool infeed is .001" and can range up to .002"
- Traverse rates can range from 12 IPM to 24 IPM and can go to 40 IPM where the only wheel requirement is stock removal.
- Slower traverse rates result in a wheel face that produces less stock removal and improved finish.
- Faster traverse rates result in a wheel face that produces greater stock removal and a rougher finish.
- When first installing a grit dresser tool, make 4 or 5 passes at .005" infeed to ensure full face contact between the dressing tool and the wheel face.

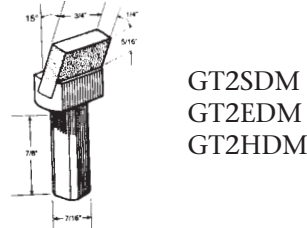
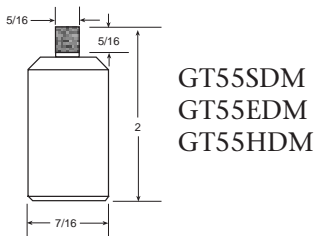
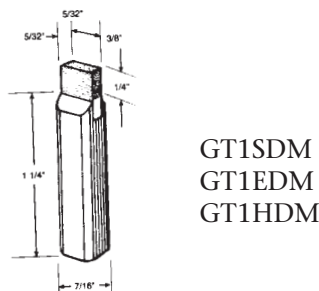
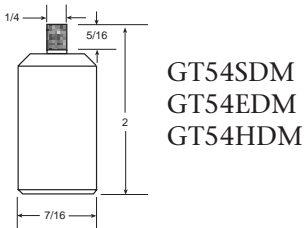
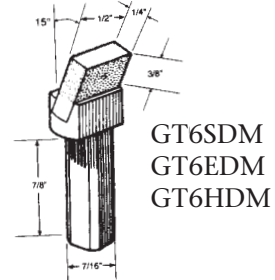
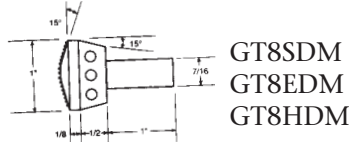
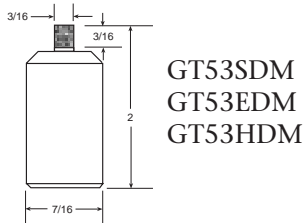
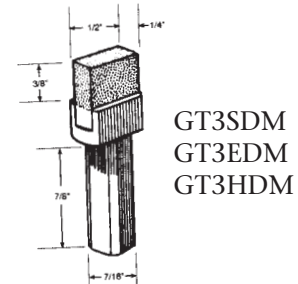
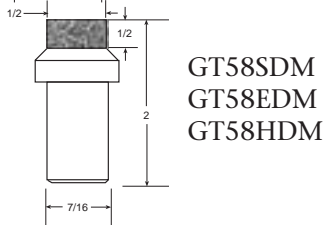
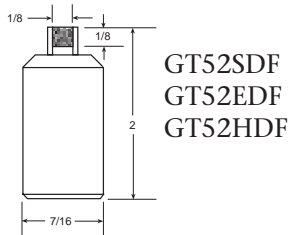
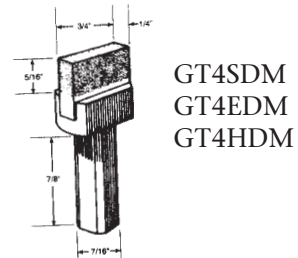
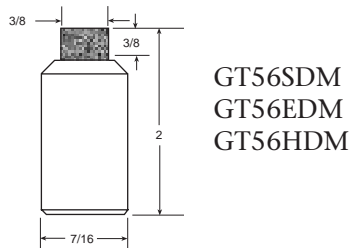
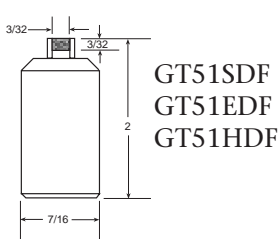

HOW TO ORDER

	GT2	ED	M	
Style of Shank & Diamond Section	Concentration SD = 75% ED = 100% HD = 125%	Diamond Size VC = Very Course C = Course M = Medium (Standard) F = Fine B1 = for Coarse CBN Wheels B2 = For Fine CBN Wheels	Grit Size of Abrasive Wheel 24, 30, 36 46 60 80, 100	

OFF HAND DRESSER

TOOL #	DIAMOND SELECTION	DIAMOND DEPTH
HGT3	1/2 x 1/4	3/8"
HGT4	3/4 x 1/4	3/8
HGT54	1/4 Round	5/16
HGT58	1/2 Round	3/8

Shank Diameter 5/8"
O.A.L. = 8"

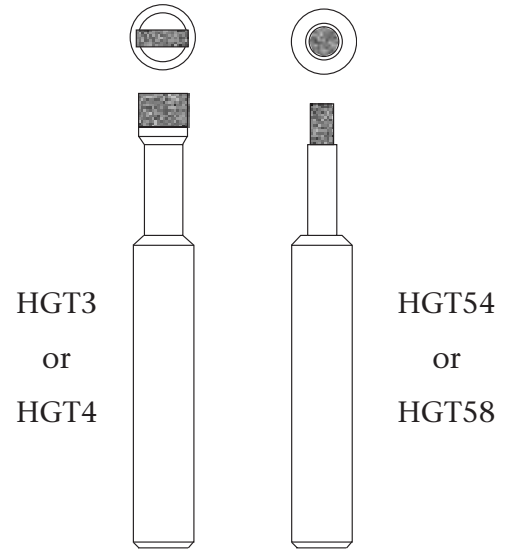

PHONO POINTS

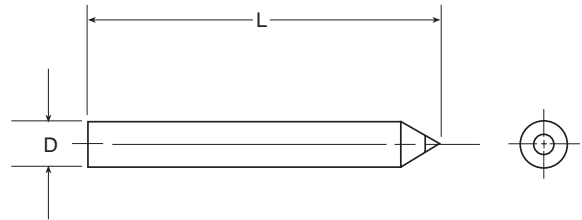

ANGLE	DIA. SIZE NO.	SHANK SIZE	
		Inch	Metric
60	30	.081	1 or 2
		1/8	3
		3/16	4
		1/4	5 or 6
	40	.081	1 or 2
		1/8	3
		3/16	4
		1/4	5
	50	.081	3 - 6
		1/8	
		3/16	
		1/4	
60	.081	3 - 6	
	1/8		
	3/16		
	1/4		
70	.081	3 - 6	
	1/8		
	3/16		
	1/4		
75	30	.081	1 or 2
		1/8	3
		3/16	4
		1/4	5 or 6
	40	.081	1 or 2
		1/8	3
		3/16	4
		1/4	5
	50	.081	3-6
		1/8	
		3/16	
		1/4	

ANGLE	DIA. SIZE NO.	SHANK SIZE	
		Inch	Metric
60	60	.081	3-6
		1/8	
		3/16	
		1/4	
70	60	.081	3-6
		1/8	
		3/16	
		1/4	
90	30	.081	1-2
		1/8	3
		3/16	4
		1/4	5-6
	40	.081	1-2
		1/8	3
		3/16	4
		1/4	5-6
	50	.081	3-6
		1/8	
		3/16	
		1/4	
60	.081	3-6	
	1/8		
	3/16		
	1/4		
70	.081	3-6	
	1/8		
	3/16		
	1/4		

HOW TO ORDER

Tool # PP B - 2 40

Angle
B=60
C=75
D=90

Shank Diameter
2=1/8
3=3/16
4=1/4
1" long standard length

Diamond Size
30-(Standard Duty)
40-(Heavy Duty)
50
60
70

DIAMOND SIZE: Finished Stone
Base of Diamond

30 = .022 to .030
40 = .032 to .040
50 = .042 to .050
60 = .052 to .060
70 = .062 to .070

MICRO RADIUS DRESSERS CONCAVE TYPE

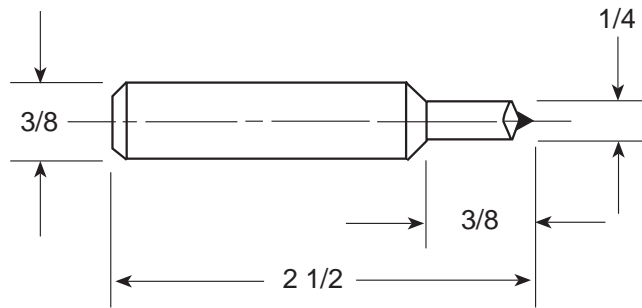

HOW TO ORDER

MC 2 HD 6

Tool # Radius Tool Size HD SD ND Shank Size
6 = 3/8
7 = 7/16

Radius to be Dressed	Heavy Duty	Standard Duty	Natural Duty
.005 - .010	MC1HD6	MC1SD6	MC1ND6
.010 - .025	MC2HD6	MC2SD6	MC2ND6
.025 - .040	MC3HD6	MC3SD6	MC3ND6
.040 - .062	MC4HD6	MC4SD6	MC4ND6
.062 - .125	MC5HD6	MC5SD6	MC5ND6
.125 - .250	MC6HD6	MC6SD6	MC6ND6

For dressing a concave radius into the corner of a grinding wheel.

The diamond is concentric with the shank to form the desired radius.

Heavy duty and standard are lapped maacle diamonds for precision dressing. Heavy duty tools have larger diamonds.

Natural duty are natural maacle shaped diamonds.

MICRO RADIUS DRESSERS CONVEX TYPE

HOW TO ORDER

MV 2 HD 6

Tool # Radius Tool Size HD SD Shank Size
6 = 3/8
7 = 7/16

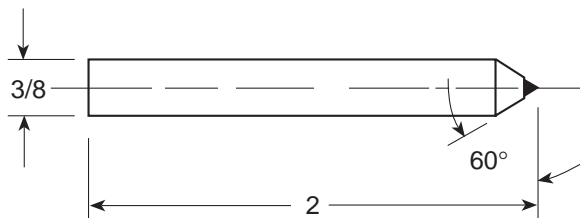

Radius to be Dressed	Heavy Duty	Standard Duty
.015 - .032	MV1HD6	MV1SD6
.032 - .062	MV2HD6	MV2SD6
.062 - .125	MV3HD6	MV3SD6
.125 - .250	MV4HD6	MV4SD6
.250 - .500	MV5HD6	MV5SD6

For dressing a convex radius on the corner of a grinding wheel. Convex dressers have a sharp point on diamond selected to generate the radius to be dressed. The stone is set concentric with the shank. Heavy duty types have larger stones than standard types.

CHISEL DRESSERS

For form dressing radius and contours on grinding wheels. Our standard chisels are precision lapped diamond having a .005 flat on tip. Standard radius on diamond is .003 - .005. Standard shank length is 3". Other radius available at an additional charge. When ordering add radius at end of tool no. (ex: CH3B6.005R).

TOOL NUMBER	DIAMOND WEIGHT	*A= 40°	*B= 60°	*C= 75°	*D= 90°
CH1 * 6	1/5				
CH2 * 6	1/4				
CH3 * 6	1/3				
CH5 * 6	1/2				
CH7 * 6	3/4				

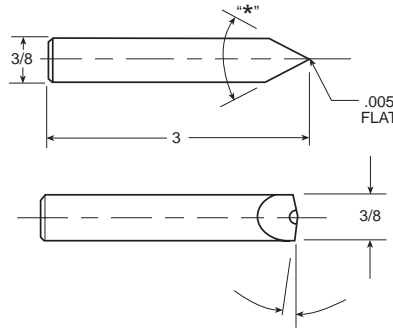

HOW ORDER

CH 3 B 6

Tool Type: CH
Diamond Size: 3
Included Angle on Diamond: B
Shank Size: 6

4 = 1/4
6 = 3/8
7 = 7/16
8 = 1/2

A = 40
B = 60
C = 75
D = 90

Relapping available.

CONE POINTS

For form dressing the diamond in the tool is accurately coned to the specified included angle and radius. These tools are used for precision dressing. Standard radius on diamond is .003-.005. Standard shank length is 2". Other radius available at an additional charge. When ordering add radius at end of tool no. (ex: CH3B6.005R).

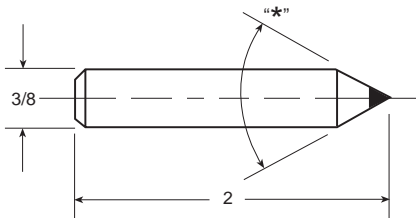

TOOL NUMBER	DIAMOND SIZE	*B=60°	*C=75°	*D=90°
CP1 * 6	1/5			
CP2 * 6	1/4			
CP3 * 6	1/3			
CP5 * 6	1/2			

Resetting and Reconing available.

HOW TO ORDER

CP 3 B 6

Tool Type: CP
Diamond Size: 3
Included Angle on Diamond: B
Shank Size: 6

1 = 1/5 CT
2 = 1/4 CT
3 = 1/3 CT
5 = 1/2 CT

B = 60°
C = 75°
D = 90°

4 = 1/4
5 = 5/16
6 = 3/8
7 = 7/16
8 = 1/2

DIAFORMS

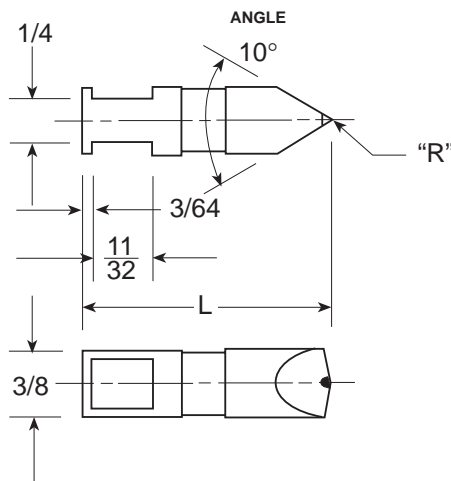

Tool #	Angle	Radius
PWA1*	40°	.005
PWA2*	40°	.010
PWA3*	40°	.020
PWB1*	60°	.005
PWB2*	60°	.010
PWB3*	60°	.020

HOW TO ORDER

PW A - 2 H

Tool Type: PW
Angle: A
Radius: 2
Length(*): H

A = 40°
B = 60°

1 = .005
2 = .010
3 = .020

G = 1 3/8
H = 1 3/4
J = 2 1/4

Other angles, radius and length available.

MOORE PANTOGRAPHS

Tool #	Angle	Radius
MP1A	40	.005
MP2A	40	.010
MP3A	40	.012
MP4A	40	.015
MP5A	40	.020
MP1B	60	.005
MP2B	60	.010
MP3B	60	.012
MP4B	60	.015
MP5B	60	.020

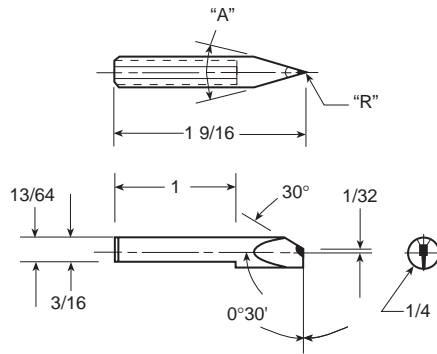

HOW TO ORDER

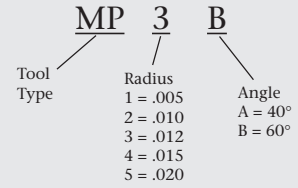

Other angles and radius available.

RATTAIL DRESSERS

To form half circle concave radii

Tool #	To Dress A Min. Radius of
RT31	.032
RT46	.046
RT62	.062
RT93	.093
RT125	.125

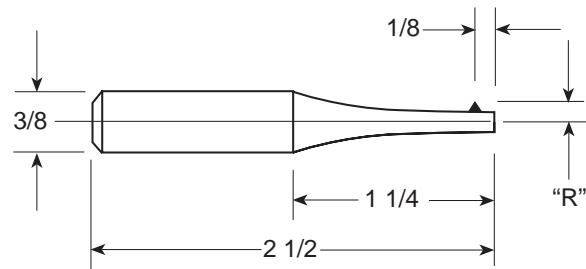

PLUNGE DRESSERS

TOOL #	RADIUS
PL.005	.005
PL.010	.010
PL.015	.015
PL.020	.020
PL.025	.025
PL.030	.030
PL.040	.040
PL.046	.046
PL.050	.050
PL.062	.062

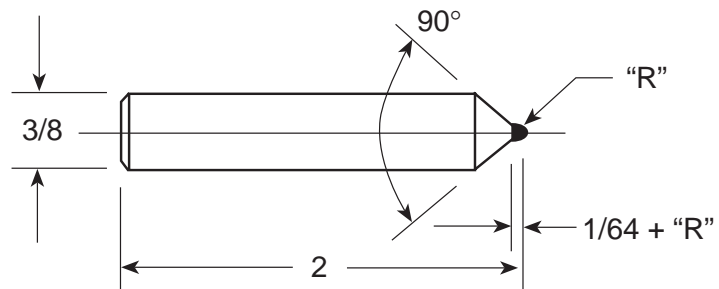

Plunge radius tools are designed to plunge dress a concave radius in the center of a grinding wheel. Frequent turning of the tool will maintain accuracy over a long period of use. For longer life the radius should be rough with a concave dresser.

Additional radius are available.
Please inquire.

Reballing available.

HOGLUND DRESSERS

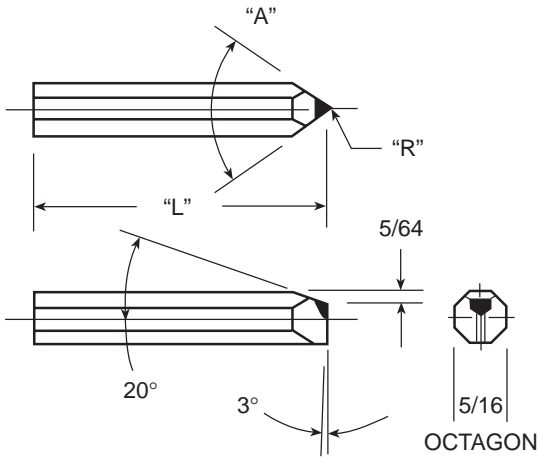

HOW TO ORDER

HG 60 .010 A

Tool Type Angle Radius Length
 A = 1 1/2
 B = 1 5/8
 C = 1 3/4

JONES & LAMSON

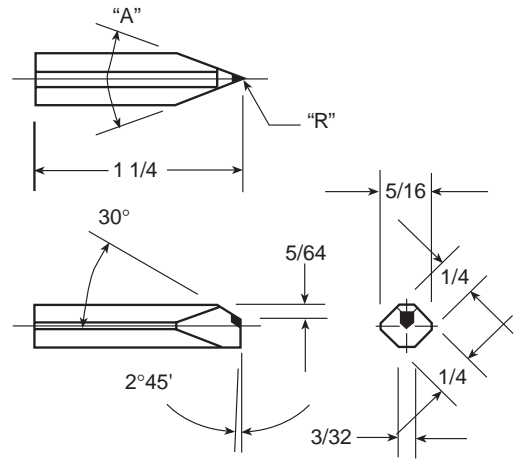

HOW TO ORDER

JL 50 .007

Tool Type Angle Radius

HARDNESS TESTERS

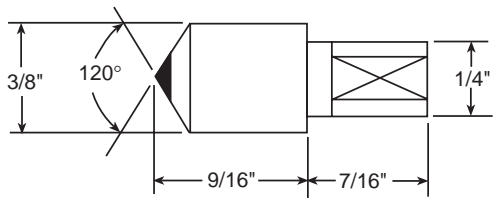

TYPE

- Rockwell "C"
- Newage: Versitron
- Newage Versitron (Tapered)

TOOL #

STANDARD	PREMIUM
HRCS	HRCP
HNVS	HNVP
HNVTS	HNVTP

Standard and premium grade available.

THREAD GRINDING DRESSERS

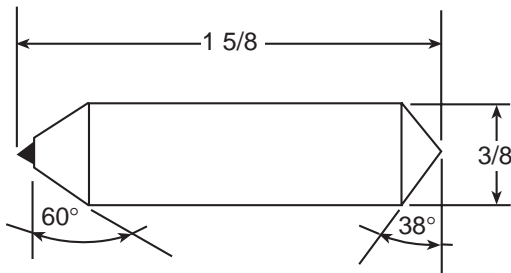

EXCELLO

TOOL #

- * EXSD
- * EXTH

* Not Resetttable

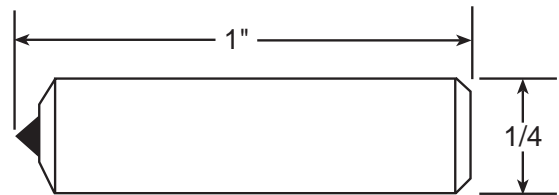

J & L

TOOL #

- * JLSD
- * JLTH

* Not Resetttable

"LUSTER LAP" DIAMOND LAPPING COMPOUNDS

Our rigid concentration standards mean less cost to you for diamond lapping compounds whether you use them for polishing or roughing because you use less compound to do more work. Our diamond powder is carefully graded, and laboratory tested. The compounds are packed in disposable plastic syringes that allow economical application of material where it is most needed on intricate die and mold sections. Also packaged in tubes and jars if desired.

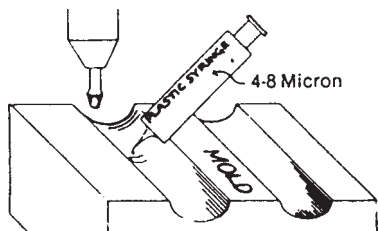

Dispensed in disposable plastic syringes or jars

Felt bobs and polishing sticks available

We recommend the following lapping media to be used with our diamond lapping compounds to obtain the highest possible finishes:

APPLICATION

Fast Stock Removal
Light Stock Removal and Finishing
Light Finishing and Superfinishing

MEDIA: MATERIALS

Cast Iron or Mild Steel
Copper or Plastic Laminated Materials
Cotton or Felt or Wood

Order symbol: **100 concentration = strong

Compounds: Oil soluble (standard); Water Soluble order with a (W) at end of order number. EX: SLC5W

Used for	** Lusterlap Order Number	Micron Range	(USBS) Grade	Theoretical Sieve Size	Color	Concentration
Superfinishing	SLC 1/4	0 - 1/2		120,000	Brown	Strong
Metallographic Specimens	SLC 1/2	0-1		60,000	Lt. Blue	Strong
Metallographic Specimens	SLC 1	0-2	1	14,000	Purple	Strong
Extra High	SLC 2	2-4	2	12,000	Lt. Green	Strong Medium
High Finishing or Polishing	SLC 3 MLC 3	1-5	3	8,000	Ivory	Strong Medium
Fine Finishing	SLC 6 MLC6	4-8	6	3,000	Yellow	Strong Medium
Finishing	SLC 8 MLC 8	6-10	8	1,800	Red	Strong Medium
Light Stock Removal	SLC 15 MLC 15	10-20	15	1,200	Blue	Strong Medium
	SLC 25 MLC 25	20-30	25	600	Dk. Green	Strong Medium
	SLC 30 MLC 30	20-40	30	500	Orange	Strong Medium
Stock Removal	SLC 40 MLC 40	30-50	40	325	Lt. Red	Strong Medium
Fast Stock... Removal	SLC 60 MLC 60	40-70	60	230	Dk. Grey	Strong Medium
	SLC 90 MCL 90	60-90	90	170	Black	Strong Medium

SYNFLEX™ POLISHING BOBS

Man made Synflex™ offers unmatched polishing performance when using diamond and other compounds. Its uniform density and felt-like properties guarantee complete consistency from lot to lot. More aggressive than felt...Synflex™ requires less polishing compound yielding greater efficiency, faster polishing and greater economy.

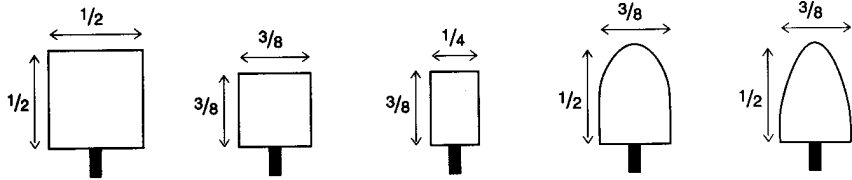

Hard	291-1104	291-1102	291-1101	291-1030	291-1010
Soft	292-1104	292-1102	292-1101	292-1030	292-1010

Twelve piece minimum order - please order in multiples of 12 - 3mm shank available

FELT BOBS

Made from the finest 100% wool for long life. Available mandrel mounted or unmounted. May be used with various polishing compounds to produce a clean, high finish on molds, dies and models. Hard, medium and soft grades available in most shapes. All measurements in inches. All 1/8" shank unless otherwise indicated.

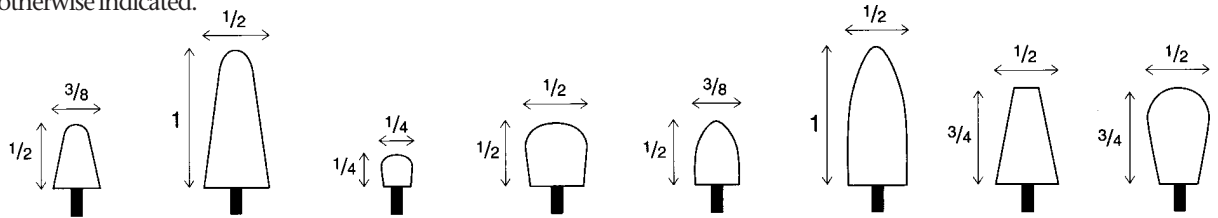

Hard	286-1010	286-1011	286-1020	286-1022	286-1030	286-1031	286-1040	286-1051
Medium	290-1010	-	290-1020	290-1022	290-1030	-	-	-
Soft	289-1010	-	289-1020	289-1022	289-1030	-	-	-

Hard (3 mm Shank)	287-1010	-	287-1020	-	-	-	-	-
-------------------	----------	---	----------	---	---	---	---	---

Twelve piece minimum order - please order in multiples of 12.

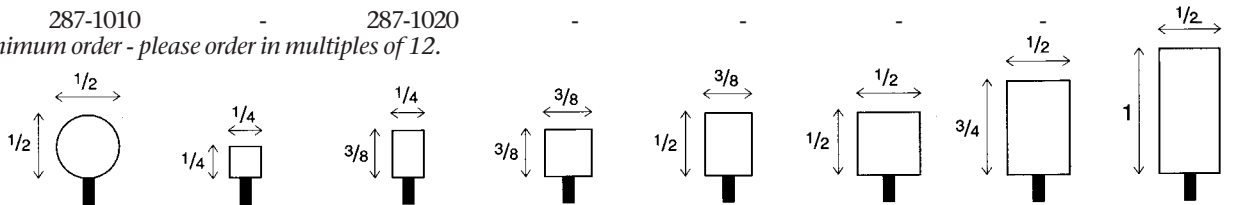

Hard	286-1060	286-1100	286-1101	286-1102	286-1103	286-1104	286-1105	286-1106
Medium	-	290-1100	290-1101	290-1102	290-1103	290-1104	290-1105	290-1106
Soft	-	289-1100	289-1101	289-1102	289-1103	289-1104	289-1105	289-1106

Hard (3 mm Shank)	-	287-1100	287-1101	287-1102	287-1103	287-1104	287-1105	-
-------------------	---	----------	----------	----------	----------	----------	----------	---

Twelve piece minimum order - please order in multiples of 12.

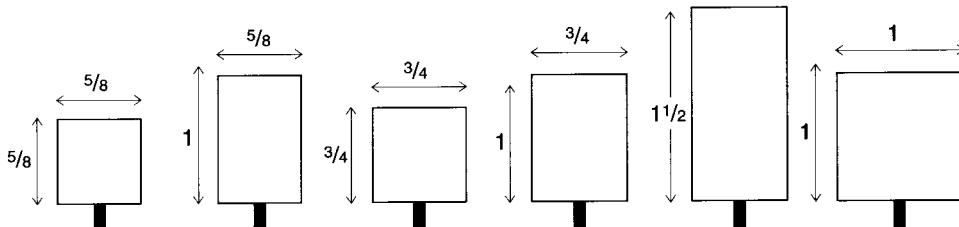

Hard	286-1107	286-1108	286-1110	286-1111	286-1113	286-1114
Medium	290-1107	290-1108	290-1110	-	-	290-1114
Soft	289-1107	289-1108	289-1110	-	-	289-1114

Hard (3 mm Shank)	-	-	287-1110	287-1111	-	287-1114
-------------------	---	---	----------	----------	---	----------

Hard (1/4" Shank)	-	-	-	-	-	286-1115
-------------------	---	---	---	---	---	----------